

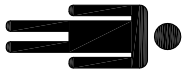









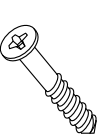
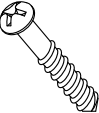
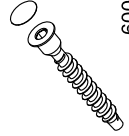

Тумба наполненная 60 "ХЕЛЕНА" СТЛ.276.05

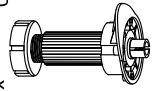
Фасад может быть навешан как на левую так и на правую боковины.

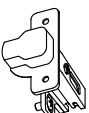

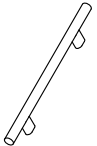
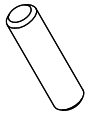
0059		x12	0032		4x13	x4	0035		4x20	x16	0039		4x35	x4	0031		3,5x30	x2
0009		7x50	x8	0080		Ø8	x16	0079		Ø5	x18	0285		H=100	x4	0286		x2
0005		H=2	x2	0054			x4	0101		L=160 mm	x1	0045		8x30	x8	0078		x6
0016		D=5 mm	x2															

Поз	Размер	Кол-во	Упаковка
1	720x560x16	1	пакет 1
2	720x560x16	1	пакет 1
3	568x80x16	2	пакет 1
4	568x544x16	1	пакет 1
5	716x582x3	1	пакет 1
6	566x540x16	1	пакет 1

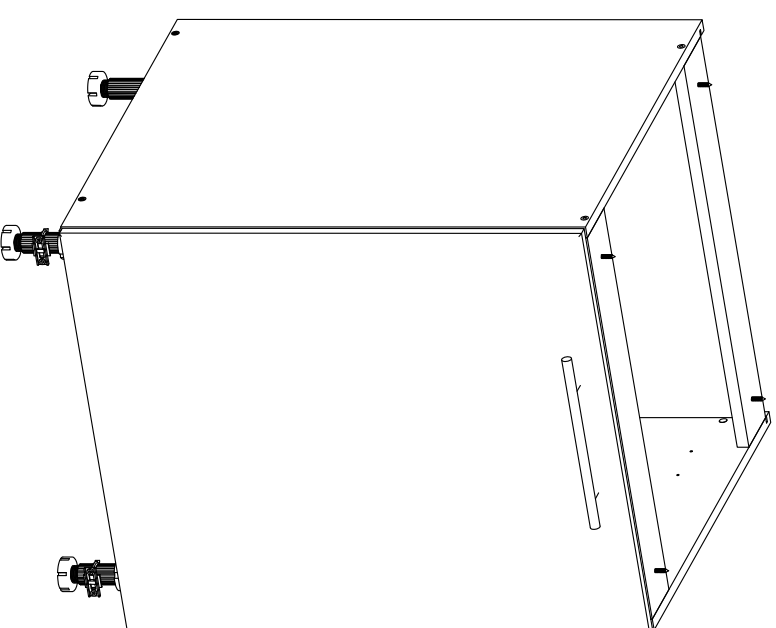

К данному корпусу фасад приобретается отдельно. СТЛ.276.09 - 1 шт.

Ø 8СКВ.
досверлить под
евровинт в зависимости
от положения планки

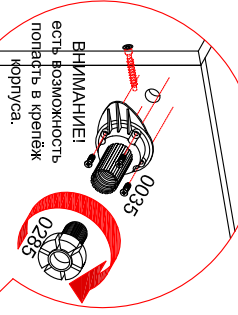
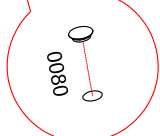
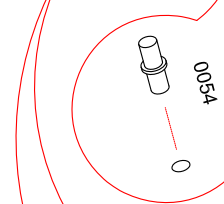
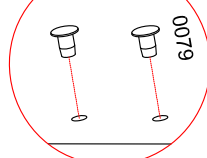
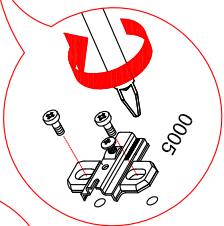
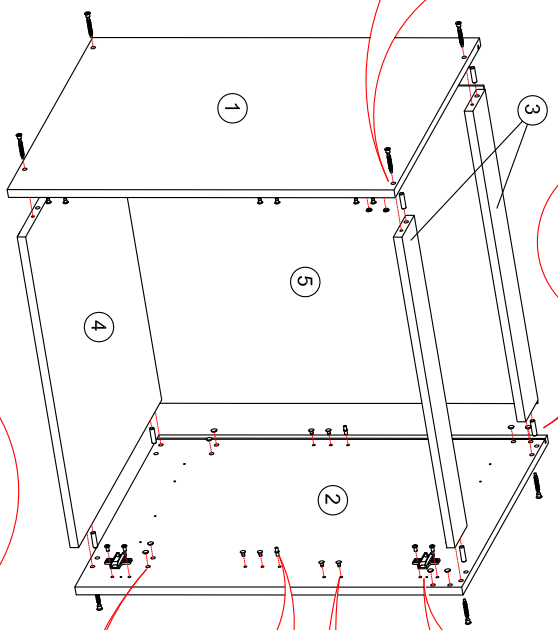
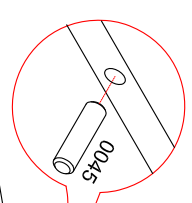
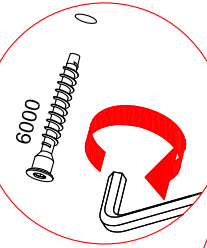

ВНИМАНИЕ!
есть возможность
попасть в крепеж
корпуса.

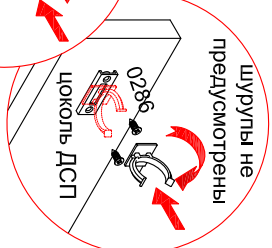
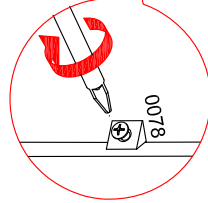
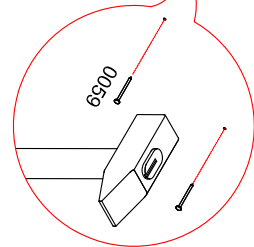
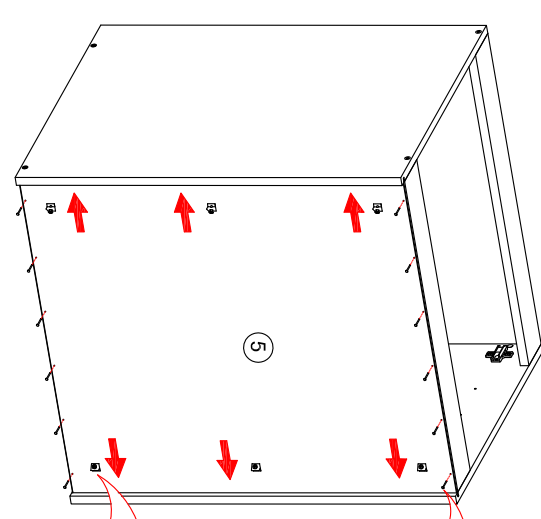
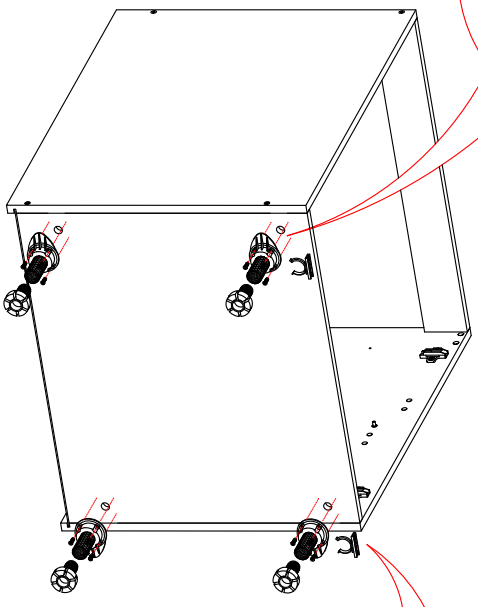

Шурупы не
предусмотрены

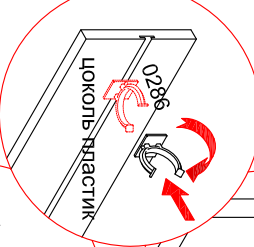

Локоль-настик

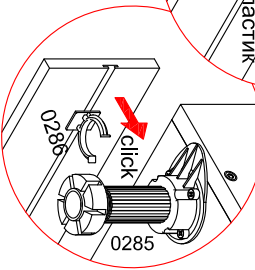

click

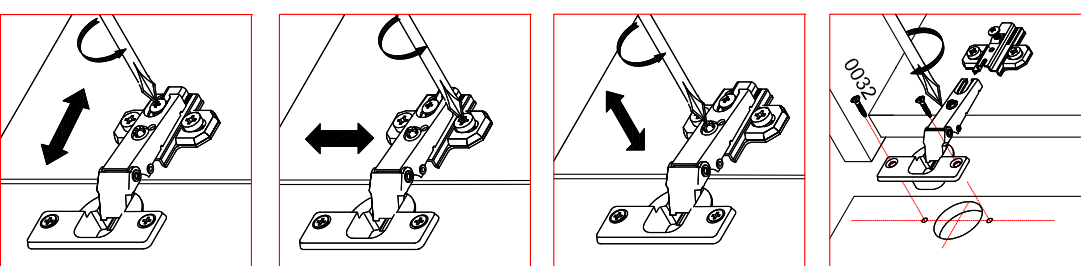
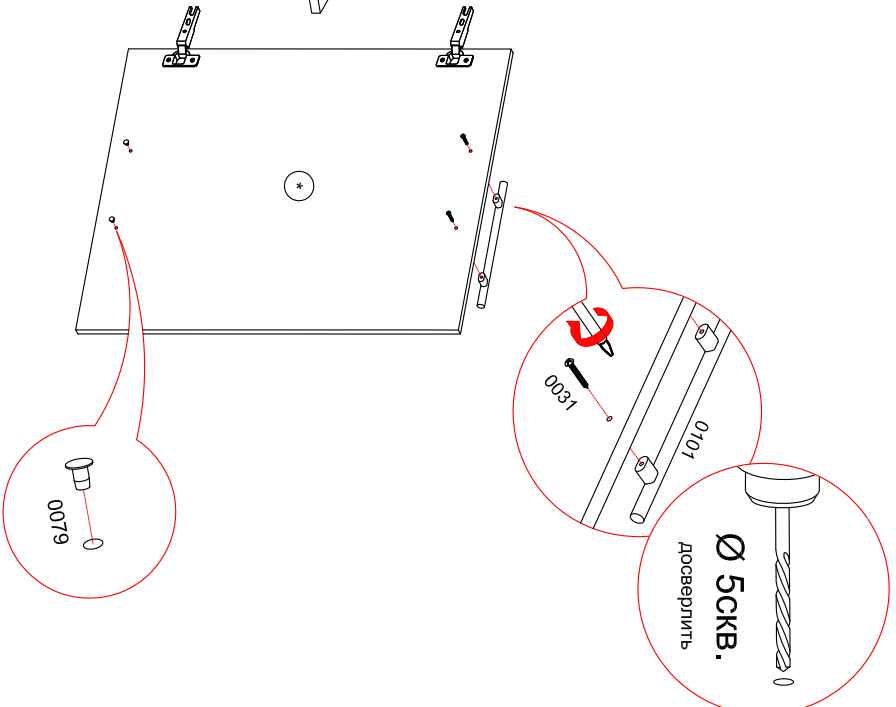
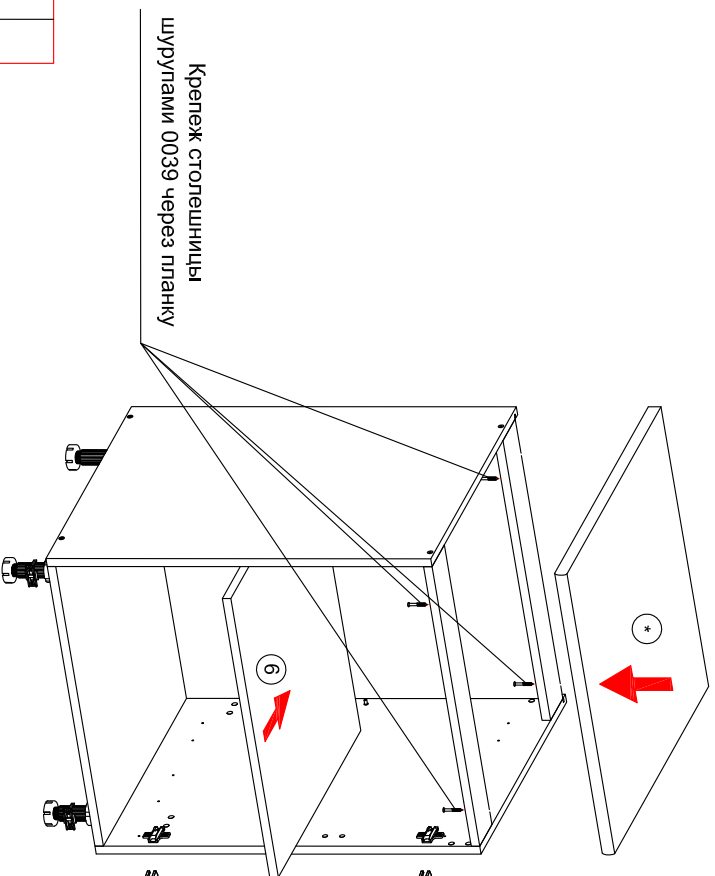
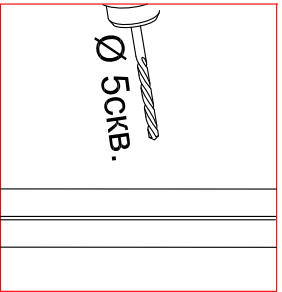
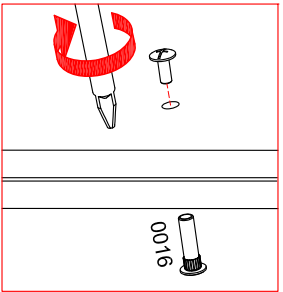

Стяжка 0016 используется для стягивания м/у собой двух корпусов.

* - фасад и столешница приобретаются отдельными комплектами